

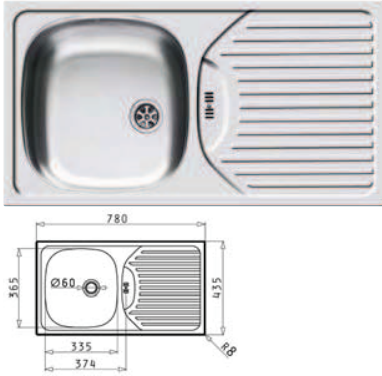

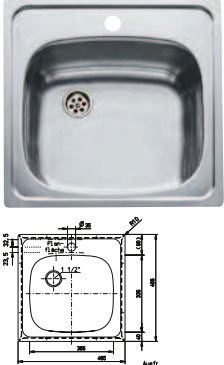

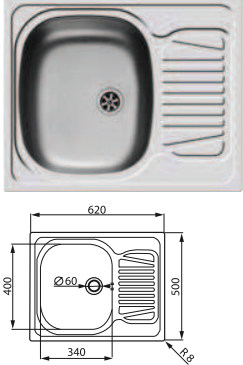

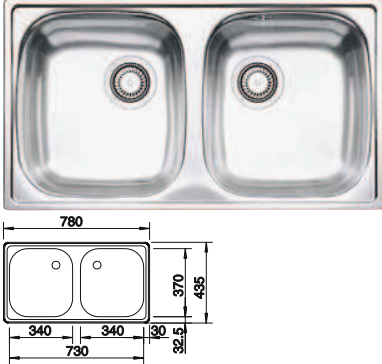

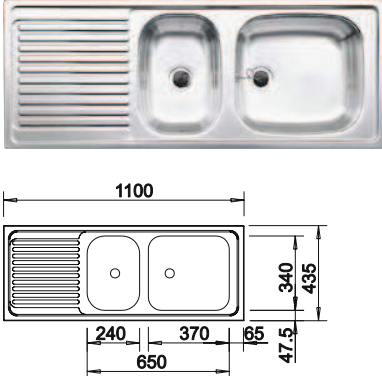
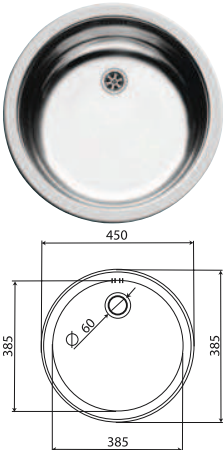

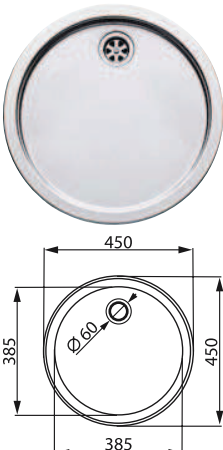

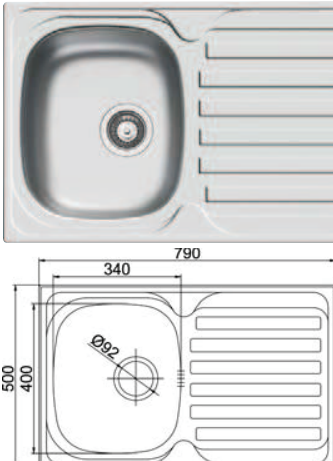
Einbauspülen

	Beschreibung	Kurzbezeichnung	N
	<p>Einbauspüle</p> <ul style="list-style-type: none"> • 1 Becken • 1,5" Stopfenventil • Separater Resteausguss • Ab- und Überlaufgarnitur <p>Maße:</p> <ul style="list-style-type: none"> • Beckengröße: 335 x 365 x 150 mm • Außenmaße: 780 x 435 mm (B x T) • Ausschnittmaße: 760 x 415 mm (B x T) • Spülenunterbau ab 45 cm <p>Ausführung/Farbe:</p> <ul style="list-style-type: none"> • Edelstahl Ziehglanz ohne Lochbohrung • Edelstahl Ziehglanz, Becken rechts und Lochbohrung • Edelstahl Ziehglanz, Becken links und Lochbohrung 	<p>ZSP 002 ZSP 003 R ZSP 003 L</p>	<p>58 74 74</p>
	<p>Einbauspüle</p> <ul style="list-style-type: none"> • 1 Becken • 3,5" Excenter-Siebkorbventil • Ablaufgarnitur • Inklusive Hahnlochbohrung <p>Maße:</p> <ul style="list-style-type: none"> • Beckengröße: 365 x 335 x 160 mm • Außenmaße: 465 x 465 mm (B x T), R10 • Ausschnittmaße: 445 x 445 mm (B x T), R10 • Spülenunterbau ab 45 cm • Nicht am Zeilenende oder neben Hochschränken einbaubar. <p>Ausführung/Farbe:</p> <ul style="list-style-type: none"> • Edelstahl poliert 	<p>ZSP 135 E</p>	<p>95</p>
	<p>Einbauspüle</p> <ul style="list-style-type: none"> • 1 Becken mit verkürzter Abtropffläche • 1,5" Stopfenventil • Überlauf im Becken • Ab- und Überlaufgarnitur • Reversibel <p>Maße:</p> <ul style="list-style-type: none"> • Beckengröße: 340 x 400 x 150 mm • Außenmaße: 620 x 500 mm (B x T) • Ausschnittmaße: 600 x 480 mm (B x T) • Spülenunterbau ab 45 cm <p>Ausführung/Farbe:</p> <ul style="list-style-type: none"> • Edelstahl Ziehglanz 	<p>ZSP 116 E</p>	<p>122</p>
	<p>Einbauspüle</p> <ul style="list-style-type: none"> • 2 Becken • 1,5" Stopfenventil • Ab- und Überlaufgarnitur <p>Maße:</p> <ul style="list-style-type: none"> • Beckengröße: 2 x 340 x 370 x 150 mm • Außenmaße: 780 x 435 mm (B x T) • Ausschnittmaße: 762 x 417 mm (B x T) • Spülenunterbau ab 80 cm <p>Ausführung/Farbe:</p> <ul style="list-style-type: none"> • Edelstahl Naturfinish 	<p>ZSP 008</p>	<p>176</p>
	<p>Einbauspüle</p> <ul style="list-style-type: none"> • 1,5 Becken • 1,5" Stopfenventil • Ab- und Überlaufgarnitur • Reversibel <p>Maße:</p> <ul style="list-style-type: none"> • Beckengröße: 370 x 340 x 150 mm & 240 x 340 x 145 mm • Außenmaße: 1100 x 435 mm (B x T) • Ausschnittmaße: 1082 x 417 mm (B x T) • Spülenunterbau ab 80 cm <p>Ausführung/Farbe:</p> <ul style="list-style-type: none"> • Edelstahl Naturfinish 	<p>ZSP 009</p>	<p>198</p>

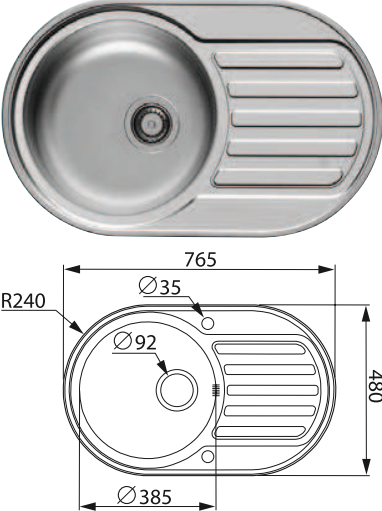
Spülenunterbau ab 45 cm

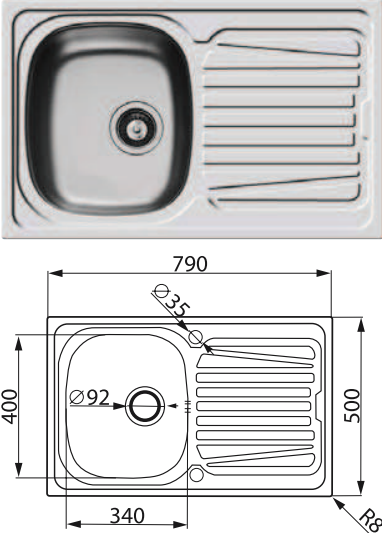
	Beschreibung	Kurzbezeichnung	N	
	<p>Rundbeckenspüle CR</p> <ul style="list-style-type: none"> • 1 Becken • 1,5" Stopfventil • Ab- und Überlaufgarnitur • Ausräschtabelle beiliegend <p>Maße:</p> <ul style="list-style-type: none"> • Beckengröße: Ø 385 x 150 mm • Außenmaße: Ø 450 mm • Ausschnittmaße: Ø 430 mm • Spülenunterbau ab 45 cm ohne Tropfasse • Spülenunterbau ab 60 cm mit Tropfasse <p>Ausführung/Farbe:</p> <ul style="list-style-type: none"> • Edelstahl Ziehglanz <p>Tropfasse CT</p> <p>Zur Kombination mit Rundbeckenspüle CR</p> <ul style="list-style-type: none"> • 1,5" Stopfventil • Ablaufgarnitur • Ausräschtabelle beiliegend <p>Maße:</p> <ul style="list-style-type: none"> • Beckengröße: Ø 385 x 30 mm • Außenmaße: Ø 450 mm • Ausschnittmaße: Ø 430 mm • Spülenunterbau ab 60 cm mit Rundbeckenspüle <p>Ausführung/Farbe:</p> <ul style="list-style-type: none"> • Edelstahl Ziehglanz 		<p>ZSP 117 E</p>	<p>129</p>
	<p>Kiba</p> <ul style="list-style-type: none"> • 1 Becken • 3,5" Siebkorbstopfventil • Überlauf im Becken • Ab- und Überlaufgarnitur • Inklusive Hahnlochbohrung <p>Maße:</p> <ul style="list-style-type: none"> • Beckengröße: Ø 385 x 163 mm • Außenmaße: Ø 485 mm • Ausschnittmaße: Ø 465 mm • Spülenunterbau ab 45 cm • Nicht am Zeilenende oder neben Hochschranke einbaubar bei Spülenunterbau ab 45 cm <p>Ausführung/Farbe:</p> <ul style="list-style-type: none"> • Edelstahl poliert 		<p>ZSP 140 E</p>	<p>143</p>
	<p>Derby 1B 1D</p> <ul style="list-style-type: none"> • 1 Becken • 3,5" Siebkorbstopfventil • Überlauf im Becken • Ab- und Überlaufgarnitur • Reversibel <p>Maße:</p> <ul style="list-style-type: none"> • Beckengröße: 340 x 400 x 150 mm • Außenmaße: 790 x 500 mm (B x T) • Ausschnittmaße: 770 x 480 mm (B x T) • Spülenunterbau ab 45 cm <p>Ausführung/Farbe:</p> <ul style="list-style-type: none"> • Edelstahl Ziehglanz 		<p>ZSP 141 E</p>	<p>170</p>

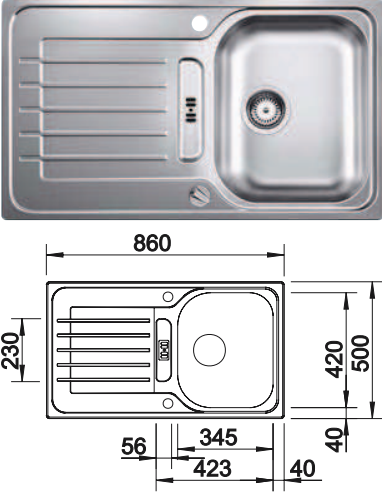

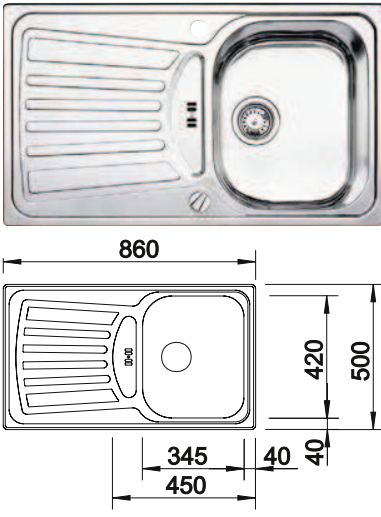
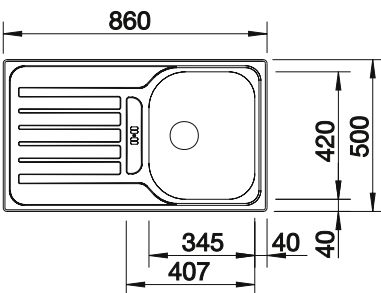

Spülenunterbau ab 45 cm

	Beschreibung	Kurzbezeichnung	N
	 <p>SR Mini</p> <ul style="list-style-type: none"> • 1 Becken • 3,5" Excenter-Siebkorbventil • Überlauf im Becken • Ab- und Überlaufgarnitur • Reversibel <p>Maße:</p> <ul style="list-style-type: none"> • Beckengröße: Ø 385 x 150 mm • Außenmaße: 765 x 480 mm (B x T) • Ausschnittmaße: 745 x 460 mm (B x T) • Spülenunterbau ab 45 cm <p>Ausführung/Farbe:</p> <ul style="list-style-type: none"> • Edelstahl Ziehlglanz 	 <p>ZSP 120 E</p>	184
	 <p>Sparta 1B 1D</p> <ul style="list-style-type: none"> • 1 Becken • 3,5" Excenter-Siebkorbventil • Überlauf im Becken • Ab- und Überlaufgarnitur • Reversibel <p>Maße:</p> <ul style="list-style-type: none"> • Beckengröße: 340 x 400 x 150 mm • Außenmaße: 790 x 500 mm (B x T) • Ausschnittmaße: 770 x 480 mm (B x T) • Spülenunterbau ab 45 cm <p>Ausführung/Farbe:</p> <ul style="list-style-type: none"> • Edelstahl Ziehlglanz 	 <p>ZSP 121 E</p>	187
	 <p>Blancozia 45 S</p> <ul style="list-style-type: none"> • 1 Becken • 3,5" Excenter-Siebkorbventil inkl. Bohrung • Separater Resteaussguss • Ablaufgarnitur mit Raumsparbogen • Inklusive Hahnlochbohrung • Reversibel <p>Maße:</p> <ul style="list-style-type: none"> • Beckengröße: 345 x 420 x 160 mm • Außenmaße: 860 x 500 mm (B x T) • Ausschnittmaße: 842 x 482 mm (B x T) • Spülenunterbau ab 45 cm <p>Ausführung/Farbe:</p> <ul style="list-style-type: none"> • Edelstahl Bürstfinish 	 <p>ZSP 125 E</p>	258

Spülenunterbau ab 45 cm

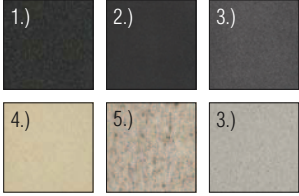
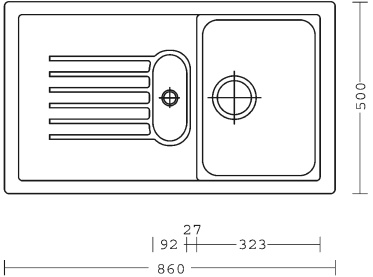
	Beschreibung	Kurzbezeichnung	N
N	 <p>Blanco Plus 45 S</p> <ul style="list-style-type: none"> • 1 Becken • 3,5" Excenter-Siebkorbventil inkl. Bohrung • Separater Resteaussuss • Ablaufgarnitur mit Raumsparbogen • Inklusive Hahnlochbohrung • Reversibel <p>Maße:</p> <ul style="list-style-type: none"> • Beckengröße: 345 x 420 x 160 mm • Außenmaße: 860 x 500 mm (B x T) • Ausschnittmaße: 842 x 482 mm (B x T), R15 • Spülenunterbau ab 45 cm <p>Ausführung/Farbe:</p> <ul style="list-style-type: none"> • Edelstahl Bürstfinish 	<p>BLANCO</p> <p>ZSP 142 E</p>	<p>228</p>
N	 <p>Blanco Santos 45 S</p> <ul style="list-style-type: none"> • 1 Becken • 3,5" Excenter-Siebkorbventil inkl. Bohrung • Separater Resteaussuss • Ablaufgarnitur mit Raumsparbogen • Inklusive Hahnlochbohrung • Reversibel <p>Maße:</p> <ul style="list-style-type: none"> • Beckengröße: 345 x 420 x 160 mm • Außenmaße: 860 x 500 mm (B x T), R15 • Ausschnittmaße: 842 x 482 mm (B x T), R15 • Spülenunterbau ab 45 cm <p>Ausführung/Farbe:</p> <ul style="list-style-type: none"> • Edelstahl Bürstfinish 	<p>BLANCO</p> <p>ZSP 143 E</p>	<p>360</p>

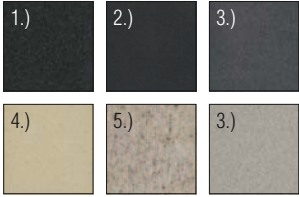
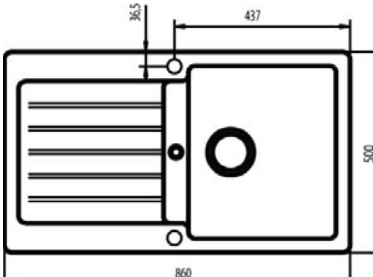



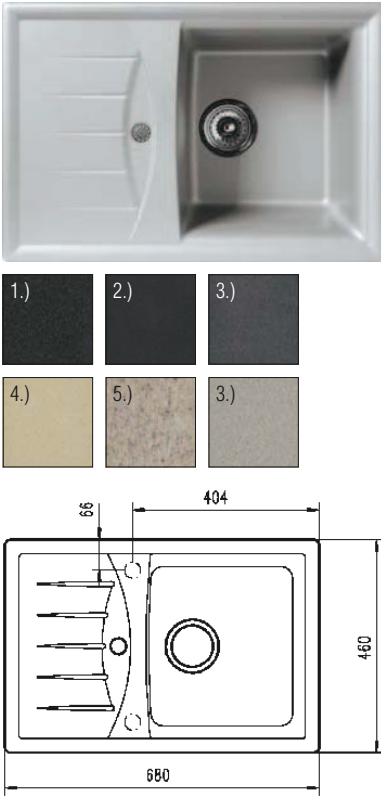
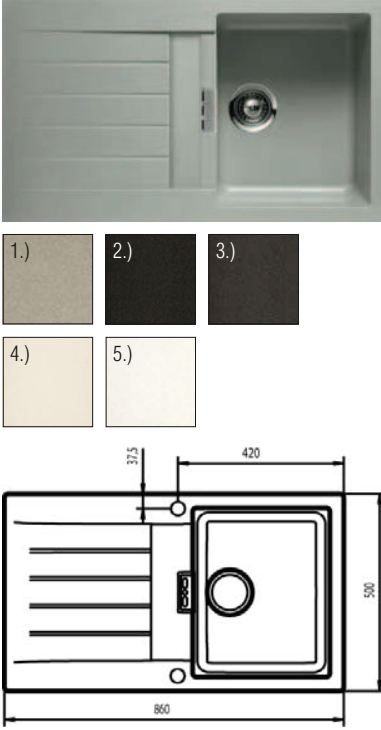

Spülenunterbau ab 45 cm

	Beschreibung	Kurzbezeichnung	N
	<div style="display: flex; justify-content: space-between;"> <div style="width: 30%;">  </div> <div style="width: 65%;"> <p>Mobile D 100</p> <ul style="list-style-type: none"> • 1 Becken • 3,5" Siebkorbstopfenventil • Separater Resteaussguss <p>Maße:</p> <ul style="list-style-type: none"> • Beckengröße: 436 x 321 x 195 mm • Außenmaße: 860 x 500 mm (B x T) • Ausschnittmaße: 840 x 480 mm (B x T) • Spülenunterbau ab 45 cm <p>Ausführung/Farbe:</p> <ol style="list-style-type: none"> 1.) Cristalite Anthrazit (Onyx) 2.) Cristalite Basaltschwarz (Nero) 3.) Cristalite Grau Metallic (Inox) 4.) Cristalite Jasmin (Colorado) 5.) Cristalite Sand (Terra) 6.) Cristalite Steingrau (Arena) </div> </div> <div style="display: flex; margin-top: 10px;"> <div style="width: 30%;">  </div> <div style="width: 65%;">  </div> </div>	 <p>ZSP 075 CA ZSP 075 CBS ZSP 075 CGM ZSP 075 CJ ZSP 075 CS ZSP 075 CSG</p>	<p>324 324 324 324 324 324</p>
	<div style="display: flex; justify-content: space-between;"> <div style="width: 30%;">  </div> <div style="width: 65%;"> <p>Typos D 100</p> <ul style="list-style-type: none"> • 1 Becken • 3,5" Siebkorbstopfenventil <p>Maße:</p> <ul style="list-style-type: none"> • Beckengröße: 329 x 429 x 200 mm • Außenmaße: 860 x 500 mm (B x T) • Ausschnittmaße: 840 x 480 mm (B x T) • Spülenunterbau ab 45 cm <p>Ausführung/Farbe:</p> <ol style="list-style-type: none"> 1.) Cristalite Anthrazit (Onyx) 2.) Cristalite Basaltschwarz (Nero) 3.) Cristalite Grau Metallic (Inox) 4.) Cristalite Jasmin (Colorado) 5.) Cristalite Sand (Terra) 6.) Cristalite Steingrau (Arena) </div> </div> <div style="display: flex; margin-top: 10px;"> <div style="width: 30%;">  </div> <div style="width: 65%;">  </div> </div>	 <p>ZSP 104 CA ZSP 104 CBS ZSP 104 CGM ZSP 104 CJ ZSP 104 CS ZSP 104 CSG</p>	<p>370 370 370 370 370 370</p>

Spülenunterbau ab 45 cm

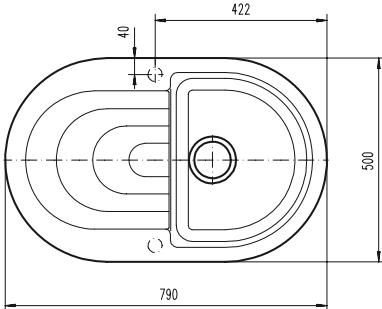
	Beschreibung	Kurzbezeichnung	N
	<p>Genius D 100 S</p> <ul style="list-style-type: none"> • 1 Becken • 3,5" Siebkorbstopfenventil • Separater Resteausguss <p>Maße:</p> <ul style="list-style-type: none"> • Beckengröße: 311 x 344 x 196 mm • Außenmaße: 680 x 460 mm (B x T) • Ausschnittmaße: 660 x 440 mm (B x T) • Spülenunterbau ab 45 cm <p>Ausführung/Farbe:</p> <ol style="list-style-type: none"> 1.) Cristalite Anthrazit (Onyx) 2.) Cristalite Basaltschwarz (Nero) 3.) Cristalite Grau Metallic (Inox) 4.) Cristalite Jasmin (Colorado) 5.) Cristalite Sand (Terra) 6.) Cristalite Steingrau (Arena) 	<p>SCHOCK sink different!</p> <p>ZSP 097 CA ZSP 097 CBS ZSP 097 CGM ZSP 097 CJ ZSP 097 CS ZSP 097 CSG</p>	<p>441 441 441 441 441 441</p>
	<p>Patos D 100</p> <ul style="list-style-type: none"> • 1 Becken • 3,5" Excenter-Siebkorbventil <p>Maße:</p> <ul style="list-style-type: none"> • Beckengröße: 347 x 430 x 195 mm • Außenmaße: 860 x 500 mm (B x T) • Ausschnittmaße: 840 x 480 mm (B x T) • Spülenunterbau ab 45 cm <p>Ausführung/Farbe:</p> <ol style="list-style-type: none"> 1.) NanoGranite AluMetallic (Lucida) 2.) NanoGranite Anthrazit (Magma) 3.) NanoGranite Carbonium (Carbonium) 4.) NanoGranite Magnolie (Magnolia) 5.) NanoGranite Weiß (Polaris) 	<p>SCHOCK sink different!</p> <p>ZSP 107 NAM ZSP 107 NA ZSP 107 NC ZSP 107 NM ZSP 107 NW</p>	<p>479 479 479 479 479</p>

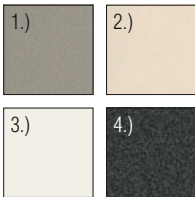
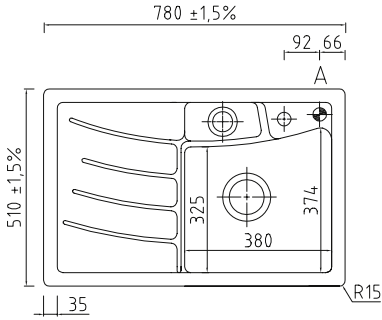
Spülenunterbau ab 45 cm

	Beschreibung	Kurzbezeichnung	N
	<div style="display: flex; justify-content: space-between;"> <div style="width: 30%;">  </div> <div style="width: 65%;"> <p>Ronda D 100 S</p> <ul style="list-style-type: none"> • 1 Becken • 3,5" Siebkorbstopfenventil • Separater Resteausguss <p>Maße:</p> <ul style="list-style-type: none"> • Beckengröße: 349 x 429 x 200 mm • Außenmaße: 790 x 500 mm (B x T) • Ausschnittmaße: 770 x 480 mm (B x T) • Spülenunterbau ab 45 cm <p>Ausführung/Farbe:</p> <ol style="list-style-type: none"> 1.) Cristalite Anthrazit (Onyx) 2.) Cristalite Basaltschwarz (Nero) 3.) Cristalite Grau Metallic (Inox) 4.) Cristalite Jasmin (Colorado) 5.) Cristalite Sand (Terra) 6.) Cristalite Steingrau (Arena) </div> </div> <div style="margin-top: 10px;">  </div> <div style="margin-top: 10px;">  </div>	 <p>ZSP 122 CA ZSP 122 CBS ZSP 122 CGM ZSP 122 CJ ZSP 122 CS ZSP 122 CSG</p>	<p>340 340 340 340 340 340</p>
	<div style="display: flex; justify-content: space-between;"> <div style="width: 30%;">  </div> <div style="width: 65%;"> <p>KeraDomo Vega 78</p> <ul style="list-style-type: none"> • 1 Becken • 3,5" Excenter-Siebkorbventil inkl. Bohrung • Separater Resteausguss mit Resteschale Makrolon • Ablaufgarnitur • Inklusive Hahnlochbohrung <p>Maße:</p> <ul style="list-style-type: none"> • Beckengröße: 380 x 324-374 x 185 mm • Außenmaße: 780 x 510 mm +/- 1,5 % (B x T), R15 • Ausschnittmaße: 750 x 480 mm (B x T), 4 x R5 • Spülenunterbau ab 45 cm <p>Ausführung Becken rechts/Farbe:</p> <ol style="list-style-type: none"> 1.) Fango 2.) Jasmin 3.) Polar 4.) Schiefer <p>Ausführung Becken links/Farbe:</p> <ol style="list-style-type: none"> 1.) Fango 2.) Jasmin 3.) Polar 4.) Schiefer </div> </div> <div style="margin-top: 10px;">  </div> <div style="margin-top: 10px;">  </div>	 <p>ZSP 128 FA ZSP 128 JA ZSP 128 PO ZSP 128 SC</p> <p>ZSP 129 FA ZSP 129 JA ZSP 129 PO ZSP 129 SC</p>	<p>822 822 755 822</p> <p>822 822 755 822</p>



Spülenunterbau ab 45 cm

	Beschreibung	Kurzbezeichnung	N
N	<div data-bbox="169 237 552 461"> </div> <div data-bbox="169 472 552 696"> </div> <div data-bbox="169 707 552 976"> </div> <p>Concerta 1B 1D</p> <ul style="list-style-type: none"> • 1 Becken • 3,5" Excenter-Siebkorbventil inkl. Bohrung • Überlauf im Becken • Ab- und Überlaufgarnitur • Inklusive Hahnlochbohrung • Reversibel <p>Maße:</p> <ul style="list-style-type: none"> • Beckengröße: 340 x 400 x 180 mm • Außenmaße: 860 x 500 mm (B x T) • Ausschnittmaße: 830 x 470 mm (B x T) • Spülenunterbau ab 45 cm <p>Ausführung/Farbe:</p> <ul style="list-style-type: none"> • Edelstahl & Glas Schwarz • Edelstahl & Glas Weiß 	 <p>ZSP 147 S ZSP 147 W</p>	<p>963 1069</p>

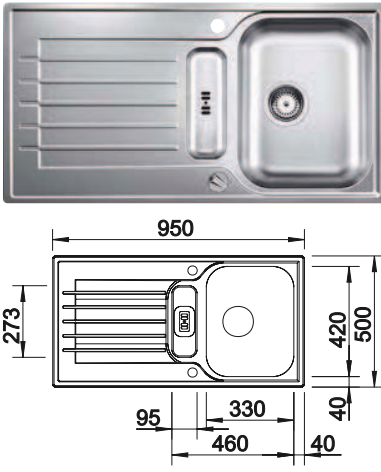
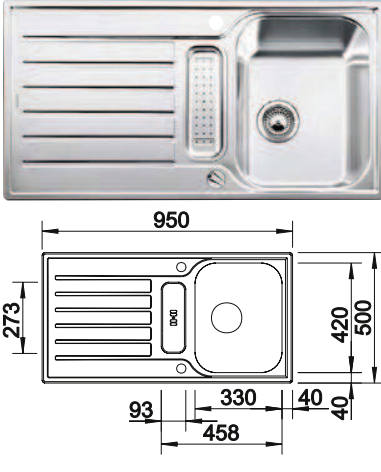
Spülenunterbau ab 50 cm

	Beschreibung	Kurzbezeichnung	N
	 <p>Blancozia 5 S</p> <ul style="list-style-type: none"> • 1 Becken • 3,5" Excenter-Siebkorbventil inkl. Bohrung • Separater Resteaussuss • Ablaufgarnitur mit Raumsparbogen • Inklusive Hahnlochbohrung • Reversibel <p>Maße:</p> <ul style="list-style-type: none"> • Beckengröße: 330 x 420 x 164 mm • Außenmaße: 950 x 500 mm (B x T) • Ausschnittmaße: 933 x 483 mm (B x T) • Spülenunterbau ab 50 cm <p>Ausführung/Farbe:</p> <ul style="list-style-type: none"> • Edelstahl Bürstfinish 	<p>BLANCO</p> <p>ZSP 126 E</p>	<p>355</p>
<p>N</p>	 <p>Blancolantos 5 S</p> <ul style="list-style-type: none"> • 1 Becken • 3,5" Excenter-Siebkorbventil inkl. Bohrung • 1 Restebecken • 1 edelstahl Resteschale • Großzügige Abtropffläche • Ablaufgarnitur mit Raumsparbogen • Inklusive Hahnlochbohrung • Reversibel <p>Maße:</p> <ul style="list-style-type: none"> • Beckengröße: 330 x 420 x 160 mm • Außenmaße: 950 x 500 mm (B x T), R15 • Ausschnittmaße: 932 x 482 mm (B x T), R15 • Spülenunterbau ab 50 cm <p>Ausführung/Farbe:</p> <ul style="list-style-type: none"> • Edelstahl Bürstfinish 	<p>BLANCO</p> <p>ZSP 144 E</p>	<p>582</p>

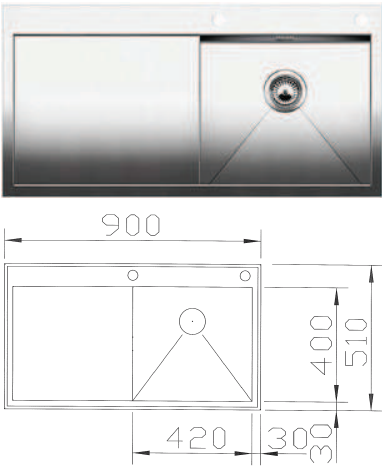
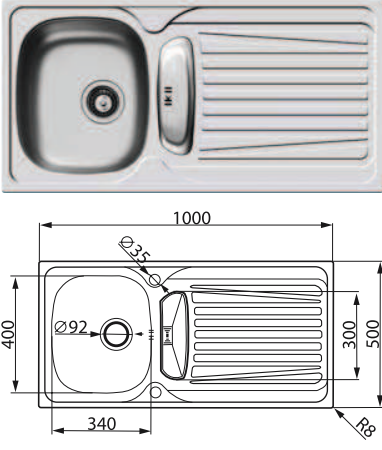

Spülenunterbau ab 50 cm

	Beschreibung	Kurzbezeichnung	N
	 <p>Cubo 45</p> <ul style="list-style-type: none"> • 1 Becken • 3,5" Excenter-Siebkorbventil <p>Maße:</p> <ul style="list-style-type: none"> • Beckengröße: 420 x 400 x 175 mm • Außenmaße: 900 x 510 mm (B x T) • Ausschnittmaße: 880 x 490 mm (B x T) • Spülenunterbau ab 50 cm <p>Ausführung/Farbe:</p> <ul style="list-style-type: none"> • Edelstahl Becken rechts • Edelstahl Becken links 	<p>ZSP 100 ER ZSP 100 EL</p>	<p>919 919</p>
	 <p>Sparta 1 1/4B 1D</p> <ul style="list-style-type: none"> • 1 Becken • 3,5" Excenter-Siebkorbventil • 1 Restebecken • 1 Kunststoff Resteschale • Überlauf im Restebecken • Ab- und Überlaufgarnitur • Reversibel <p>Maße:</p> <ul style="list-style-type: none"> • Beckengröße: 340 x 400 x 150 mm & 100 x 298 x 17 mm • Außenmaße: 1000 x 500 mm (B x T) • Ausschnittmaße: 980 x 480 mm (B x T) • Spülenunterbau ab 50 cm <p>Ausführung/Farbe:</p> <ul style="list-style-type: none"> • Edelstahl Ziehglanz 	 <p>ZSP 123 E</p>	<p>245</p>



Spülenunterbau ab 50 cm

	Beschreibung	Kurzbezeichnung	N
	<div data-bbox="167 235 550 459"> </div> <div data-bbox="167 470 470 660"> </div> <div data-bbox="167 683 534 952"> </div> <div data-bbox="558 235 989 683"> <p>Mobile D 125</p> <ul style="list-style-type: none"> • 1 Becken • 3,5° Siebkorbstopfenventil • 1 Restebecken • Edelstahl Resteschale <p>Maße:</p> <ul style="list-style-type: none"> • Beckengröße: 436 x 321 x 195 mm & 92 x 232 x 55 mm • Außenmaße: 860 x 500 mm (B x T) • Ausschnittmaße: 840 x 480 mm (B x T) • Spülenunterbau ab 50 cm <p>Ausführung/Farbe:</p> <ol style="list-style-type: none"> 1.) Cristalite Anthrazit (Onyx) 2.) Cristalite Basaltschwarz (Nero) 3.) Cristalite Grau Metallic (Inox) 4.) Cristalite Jasmin (Colorado) 5.) Cristalite Sand (Terra) 6.) Cristalite Steingrau (Arena) </div> <div data-bbox="1005 235 1173 280"> </div>	<p>ZSP 076 CA 368 ZSP 076 CBS 368 ZSP 076 CGM 368 ZSP 076 CJ 368 ZSP 076 CS 368 ZSP 076 CSG 368</p>	
	<div data-bbox="167 1198 550 1411"> </div> <div data-bbox="167 1422 367 1612"> </div> <div data-bbox="167 1624 550 1926"> </div> <div data-bbox="558 1198 941 1736"> <p>KeraDomo Mera 90</p> <ul style="list-style-type: none"> • 1 Becken • 3,5° Excenter-Siebkorbventil inkl. Bohrung • Ablaufgarnitur • Inklusive Hahnlochbohrung <p>Maße:</p> <ul style="list-style-type: none"> • Beckengröße: 410 x 385 x 185 mm • Außenmaße: 900 x 510 mm +/- 1,5 % (B x T), R5 • Ausschnittmaße: 870 x 480 mm (B x T), 4 x R5 • Spülenunterbau ab 50 cm <p>Ausführung Becken rechts/Farbe:</p> <ol style="list-style-type: none"> 1.) Fango 2.) Jasmin 3.) Polar 4.) Schiefer <p>Ausführung Becken links/Farbe:</p> <ol style="list-style-type: none"> 1.) Fango 2.) Jasmin 3.) Polar 4.) Schiefer </div> <div data-bbox="1021 1198 1173 1232"> </div>	<p>ZSP 130 FA 790 ZSP 130 JA 790 ZSP 130 PO 790 ZSP 130 SC 874</p> <p>ZSP 131 FA 790 ZSP 131 JA 790 ZSP 131 PO 790 ZSP 131 SC 874</p>	

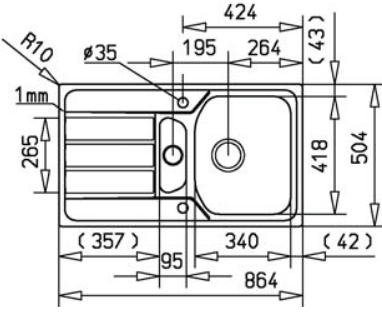



Spülenunterbau ab 50 cm

	Beschreibung	Kurzbezeichnung	N
	<div style="display: flex; justify-content: space-between; align-items: flex-start;"> <div style="width: 30%;">  </div> <div style="width: 65%;"> <p>Cano 50 BF-CN</p> <ul style="list-style-type: none"> • 1 Becken • 3,5" Excenter-Siebkorbventil inkl. Bohrung • 1 Restebecken • 1,5" Siebkorbventil • Edelstahl Resteschale • Raumsparbogen • TekaTop Rand • Inklusive Hahnlochbohrung • Reversibel </div> <div style="width: 25%; text-align: right;">  </div> </div> <div style="display: flex; justify-content: space-between; align-items: flex-start;"> <div style="width: 30%;">  </div> <div style="width: 65%;"> <p>Maße:</p> <ul style="list-style-type: none"> • Beckengröße: 340 x 418 x 155 mm • Außenmaße: 864 x 504 mm (B x T), R10 • Ausschnittmaße: 840 x 480 mm (B x T), R10,5 • Spülenunterbau ab 50 cm <p>Ausführung/Farbe:</p> <ul style="list-style-type: none"> • Edelstahl poliert </div> </div>	<p>ZSP 137 E</p>	<p>340</p>



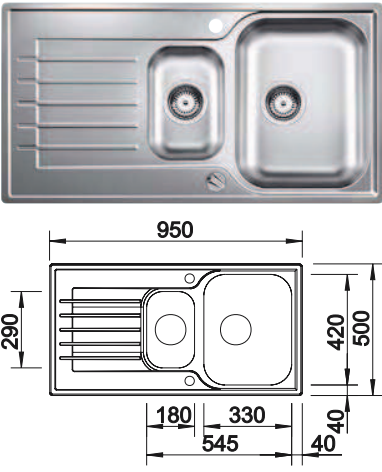

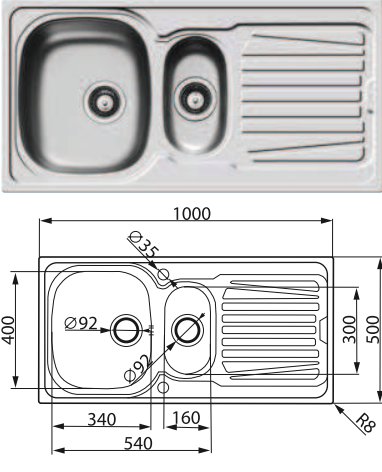









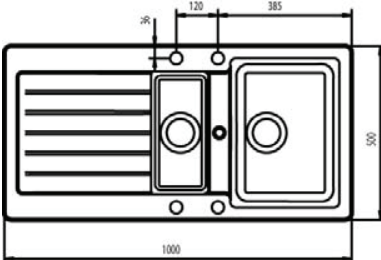

Spülenunterbau ab 50 cm

	Beschreibung	Kurzbezeichnung	N
N	<div data-bbox="167 235 550 649"> </div> <p data-bbox="558 235 702 257">Derby 1 1/2B 1D</p> <ul data-bbox="558 257 782 425" style="list-style-type: none"> • 1 Becken • 3,5° Excenter-Siebkorbventil • 1 Restebecken • 3,5° Siebkorbstopfenventil • Überlauf im Restebecken • Ab- und Überlaufgarnitur • Reversibel <p data-bbox="558 448 606 470">Maße:</p> <ul data-bbox="558 470 989 560" style="list-style-type: none"> • Beckengröße: 340 x 400 x 150 mm & 160 x 300 x 90 mm • Außenmaße: 1000 x 500 mm (B x T) • Ausschnittmaße: 980 x 480 mm (B x T) • Spülenunterbau ab 60 cm <p data-bbox="558 582 702 604">Ausführung/Farbe:</p> <ul data-bbox="558 604 718 627" style="list-style-type: none"> • Edelstahl Ziehglanz 	 <p data-bbox="1189 604 1276 627">ZSP 146 E</p>	276
N	<div data-bbox="167 1198 550 1691"> </div> <p data-bbox="558 1198 702 1220">Blancolantos 6 S</p> <ul data-bbox="558 1220 877 1422" style="list-style-type: none"> • 1 Becken • 3,5° Excenter-Siebkorbventil inkl. Bohrung • 1 Restebecken • 3,5° Siebkorbstopfenventil • 1 edelstahl Resteschale • Großzügige Abtropffläche • Ablaufgarnitur mit Raumsparbogen • Inklusive Hahnlochbohrung • Reversibel <p data-bbox="558 1444 606 1467">Maße:</p> <ul data-bbox="558 1467 893 1568" style="list-style-type: none"> • Beckengröße: 330 x 420 x 160 mm • Außenmaße: 950 x 500 mm (B x T), R15 • Ausschnittmaße: 932 x 482 mm (B x T), R15 • Spülenunterbau ab 60 cm <p data-bbox="558 1590 702 1612">Ausführung/Farbe:</p> <ul data-bbox="558 1612 718 1635" style="list-style-type: none"> • Edelstahl Bürstfinish 	 <p data-bbox="1189 1612 1276 1635">ZSP 145 E</p>	653

Spülenunterbau ab 60 cm

	Beschreibung	Kurzbezeichnung	N
	<div style="display: flex; justify-content: space-between; align-items: flex-start;"> <div style="width: 30%;">  </div> <div style="width: 65%;"> <p>Blancozia 6 S</p> <ul style="list-style-type: none"> • 1 Becken • 3,5" Excenter-Siebkorbventil inkl. Bohrung • 1 Restebecken • Ablaufgarnitur mit Raumsparbogen • Inklusive Hahnlochbohrung • Reversibel <p>Maße:</p> <ul style="list-style-type: none"> • Beckengröße: 330 x 420 x 155 mm & 180 x 290 x 155 mm • Außenmaße: 950 x 500 mm (B x T) • Ausschnittmaße: 933 x 483 mm (B x T) • Spülenunterbau ab 60 cm <p>Ausführung/Farbe:</p> <ul style="list-style-type: none"> • Edelstahl Bürstfinish </div> <div style="width: 10%; text-align: right;">  </div> </div>	ZSP 127 E	388
	<div style="display: flex; justify-content: space-between; align-items: flex-start;"> <div style="width: 30%;">  </div> <div style="width: 65%;"> <p>Sparta 1 1/2B 1D</p> <ul style="list-style-type: none"> • 1 Becken • 3,5" Excenter-Siebkorbventil • 1 Restebecken • 3,5" Siebkorbstopfenventil • Überlauf im Becken • Ab- und Überlaufgarnitur • Reversibel <p>Maße:</p> <ul style="list-style-type: none"> • Beckengröße: 340 x 400 x 150 mm & 160 x 300 x 90 mm • Außenmaße: 1000 x 500 mm (B x T) • Ausschnittmaße: 980 x 480 mm (B x T) • Spülenunterbau ab 60 cm <p>Ausführung/Farbe:</p> <ul style="list-style-type: none"> • Edelstahl Ziehglanz </div> <div style="width: 10%; text-align: right;">  </div> </div>	ZSP 124 E	263

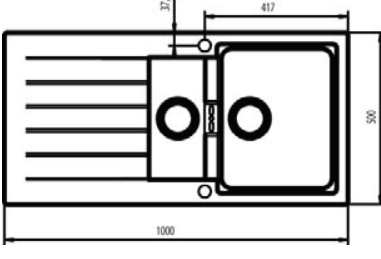

Spülenunterbau ab 60 cm

	Beschreibung	Kurzbezeichnung	N
	<div style="display: flex; justify-content: space-between; align-items: flex-start;"> <div style="width: 30%;">  <div style="display: flex; justify-content: space-around; margin-top: 10px;"> <div style="text-align: center;"> 1.)</div> <div style="text-align: center;"> 2.)</div> <div style="text-align: center;"> 3.)</div> </div> <div style="display: flex; justify-content: space-around; margin-top: 10px;"> <div style="text-align: center;"> 4.)</div> <div style="text-align: center;"> 5.)</div> <div style="text-align: center;"> 6.)</div> </div> </div> <div style="width: 65%;"> <p>Typos D 150</p> <ul style="list-style-type: none"> • 1 Becken • 3,5" Siebkorbstopfenventil • 1 Restebecken • 3,5" Siebkorbstopfenventil <p>Maße:</p> <ul style="list-style-type: none"> • Beckengröße: 312 x 429 x 200 mm & 159 x 353 x 130 mm • Außenmaße: 1000 x 500 mm (B x T) • Ausschnittmaße: 980 x 480 mm (B x T) • Spülenunterbau ab 60 cm <p>Ausführung/Farbe:</p> <ol style="list-style-type: none"> 1.) Cristalite Anthrazit (Onyx) 2.) Cristalite Basaltschwarz (Nero) 3.) Cristalite Grau Metallic (Inox) 4.) Cristalite Jasmin (Colorado) 5.) Cristalite Sand (Terra) 6.) Cristalite Steingrau (Arena) </div> <div style="width: 5%; text-align: center;">  </div> </div> <div style="width: 20%; margin-top: 10px;">  </div>	<p>ZSP 105 CA ZSP 105 CBS ZSP 105 CGM ZSP 105 CJ ZSP 105 CS ZSP 105 CSG</p>	<p>454 454 454 454 454 454</p>
	<div style="display: flex; justify-content: space-between; align-items: flex-start;"> <div style="width: 30%;">  <div style="display: flex; justify-content: space-around; margin-top: 10px;"> <div style="text-align: center;"> 1.)</div> <div style="text-align: center;"> 2.)</div> <div style="text-align: center;"> 3.)</div> </div> <div style="display: flex; justify-content: space-around; margin-top: 10px;"> <div style="text-align: center;"> 4.)</div> <div style="text-align: center;"> 5.)</div> </div> </div> <div style="width: 65%;"> <p>Patos D 150</p> <ul style="list-style-type: none"> • 1 Becken • 3,5" Excenter-Siebkorbventil • 1 Restebecken • 3,5" Siebkorbstopfenventil <p>Maße:</p> <ul style="list-style-type: none"> • Beckengröße: 344 x 430 x 195 mm & 159 x 353 x 120 mm • Außenmaße: 1000 x 500 mm (B x T) • Ausschnittmaße: 980 x 480 mm (B x T) • Spülenunterbau ab 60 cm <p>Ausführung/Farbe:</p> <ol style="list-style-type: none"> 1.) NanoGranite Alu-metallic (Lucida) 2.) NanoGranite Anthrazit (Magma) 3.) NanoGranite Carbonium (Carbonium) 4.) NanoGranite Magnolie (Magnolia) 5.) NanoGranite Weiß (Polaris) </div> <div style="width: 5%; text-align: center;">  </div> </div> <div style="width: 20%; margin-top: 10px;">  </div>	<p>ZSP 108 NAM ZSP 108 NA ZSP 108 NC ZSP 108 NM ZSP 108 NW</p>	<p>612 612 612 612 612</p>

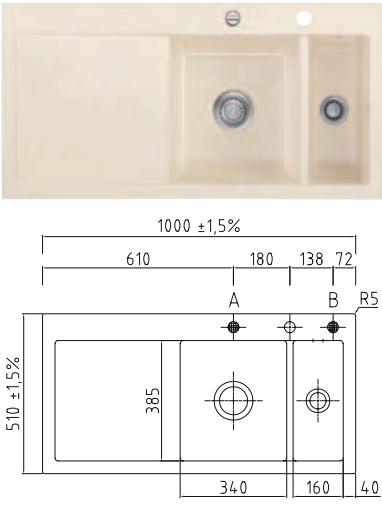
Spülenunterbau ab 60 cm

	Beschreibung	Kurzbezeichnung	N
	<div style="display: flex; justify-content: space-between; align-items: flex-start;"> <div style="text-align: center;">  </div> <div style="width: 60%;"> <p>KeraDomo Mera 100</p> <ul style="list-style-type: none"> • 1 Becken • 3,5" Excenter-Siebkorbventil • 1 Restebecken • 1,5" Siebkorbstopfenventil • Ablaufgarnitur • Inklusive Hahnlochbohrung <p>Maße:</p> <ul style="list-style-type: none"> • Beckengröße: 340 x 385 x 185 mm & 160 x 385 x 185 mm • Außenmaße: 1000 x 510 mm +/- 1,5 % (B x T), R5 • Ausschnittmaße: 970 x 480 mm (B x T), 4 x R5 • Spülenunterbau ab 60 cm <p>Ausführung Becken rechts/Farbe:</p> <ol style="list-style-type: none"> 1.) Fango 2.) Jasmin 3.) Polar 4.) Schiefer <p>Ausführung Becken links/Farbe:</p> <ol style="list-style-type: none"> 1.) Fango 2.) Jasmin 3.) Polar 4.) Schiefer </div> <div style="text-align: right; width: 15%;"> <p>systemceram <small>KeraDomo-Küchenkeramik</small></p> </div> </div>	<p>ZSP 132 FA</p> <p>ZSP 132 JA</p> <p>ZSP 132 PO</p> <p>ZSP 132 SC</p> <p>ZSP 133 FA</p> <p>ZSP 133 JA</p> <p>ZSP 133 PO</p> <p>ZSP 133 SC</p>	<p>924</p> <p>924</p> <p>924</p> <p>1007</p> <p>924</p> <p>924</p> <p>924</p> <p>1007</p>

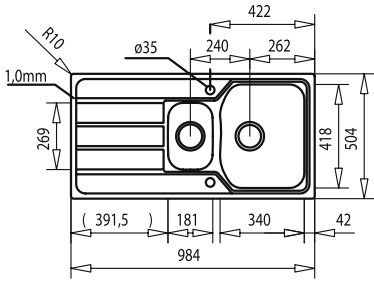
Spülenunterbau ab 60 cm, Flächenbündige Optik

	Beschreibung	Kurzbezeichnung	N
	 <p>Cano 60 Plus BF-CN</p> <ul style="list-style-type: none"> • 1 Becken • 3,5" Excenter-Siebkorbventil inkl. Bohrung • 1 Restebecken • TekaTop Rand • Raumsparbogen • Inklusive Hahnlochbohrung • Reversibel <p>Maße:</p> <ul style="list-style-type: none"> • Beckengröße: 340 x 418 x 160 mm & 181 x 269 x 144 mm • Außenmaße: 984 x 504 mm (B x T), R10 • Ausschnittmaße: 969 x 489 mm, R10 • Spülenunterbau ab 60 cm • Nicht am Zeilenende oder neben Hochschränke einbaubar. <p>Ausführung/Farbe:</p> <ul style="list-style-type: none"> • Edelstahl poliert 	 <p>ZSP 138 E</p>	<p>389</p>

Spülenunterbau 90 x 90 cm

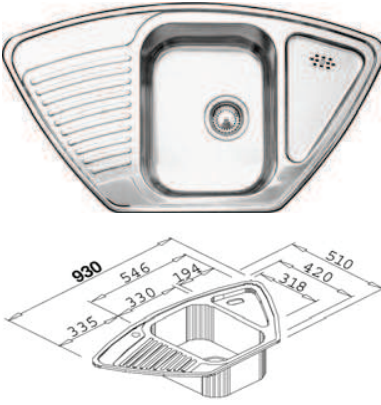
	Beschreibung	Kurzbezeichnung	N
	 <p>Blacotipo 9 E</p> <ul style="list-style-type: none"> • 1 Becken • 3,5" Siebkorbstopfenventil • Separater Resteausguss <p>Maße:</p> <ul style="list-style-type: none"> • Beckengröße: 330 x 420 x 160 mm • Außenmaße: 930 x 510 mm (B x T) • Ausschnittmaße: nach Schablone • Spülenunterbau ab 60 cm, Eckschränke ab 90 x 90 cm <p>Ausführung/Farbe:</p> <ul style="list-style-type: none"> • Edelstahl Naturfinish 	<p>BLANCO</p> <p>ZSP 050 E</p>	<p>326</p>

Zubehör für Einbauspülen

	Beschreibung	Kurzbezeichnung	N
	<p>Schlangensiphon</p> <ul style="list-style-type: none"> • Wandabschluss und Raumparventil <p>Raumparbogen</p> <ul style="list-style-type: none"> • Länge: ca. 250 mm • Passend für alle 1,5" Ablaufverbindungen 	<p>ZS 1</p> <p>ZS 2</p>	<p>20</p> <p>14</p>
N	<p>Raumpar-Syphon-Set</p> <ul style="list-style-type: none"> • Rohrgeruchsverschluss, steckbar • Mit Raumparbogen und 3 Geräteanschlüssen • Mit Syphon-Flachrohr 	ZS 4	54
N	<p>CapFlow</p> <ul style="list-style-type: none"> • Ästhetische Abdeckung des Auslaufs • Volle Funktionstüchtigkeit des Siebkorb • Ohne Umbau, universell auf jeder Spüle mit 3,5"-Auslauf einsetzbar • Spülmaschinen geeignet <p>Ausführung/Farbe:</p> <ul style="list-style-type: none"> • Edelstahl 	BLANCO	
	 	ZRS 34	34
N	<p>Stopfen für Hahnlochbohrung</p> <ul style="list-style-type: none"> • Passend für alle Einbauspülen mit 35 mm Hahnlochbohrung, wenn keine Bohrungen benötigt werden (z. B. Mischbatterie ist an der Wand befestigt) • Unterteil Kunststoff Schwarz, schraubbar <p>Ausführung/Farbe:</p> <ul style="list-style-type: none"> • Edelstahl poliert 	ZS 6	12